





\* All images are for illustrative purposes only

**Hospital TV** 75UR762M

# UL-Listed Hospital TV with NanoCell Technology

 NanoCell & Nano Bezel

 Pillow Speaker Ready

 Web-based Telemedicine Ready

 Pro:Centric Hospital Management Solution

## NanoCell TECHNOLOGY

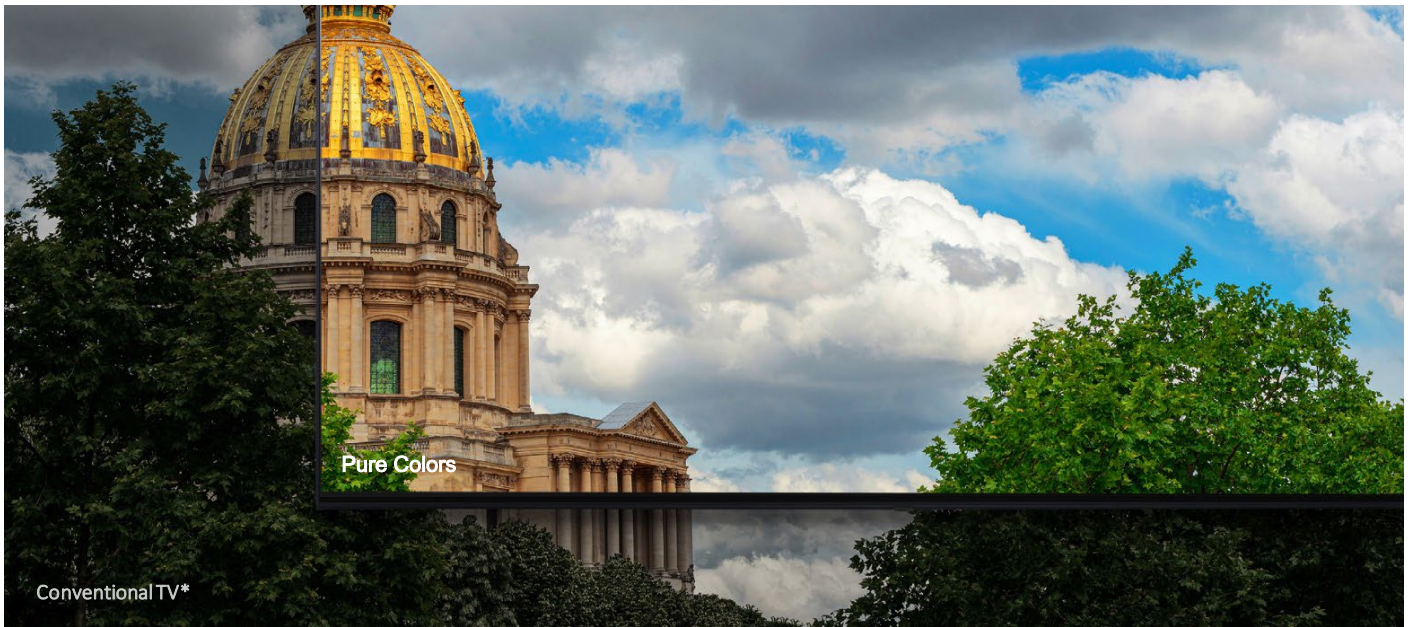

\* Conventional refers to LG's UHD TVs without NanoCell technology.

### Real 4K Made by Pure Colors

This hospital TV delivers a broad spectrum of color with advanced NanoCell technology.

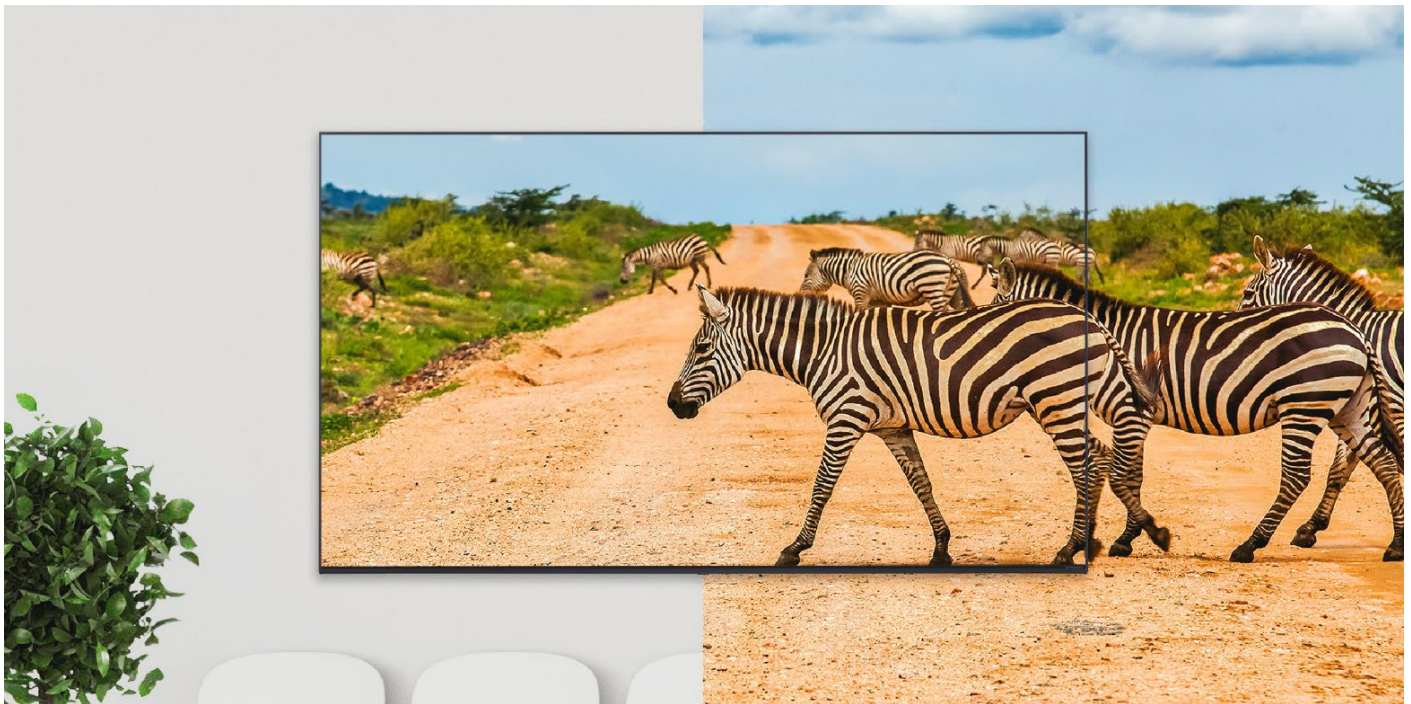

### Nano Bezel Adds Sophisticated Ambiance

The sleek, minimal bezel surround is designed to reduce distractions and blend elegantly into existing interiors for a more immersive.

## HOSPITAL-FOCUSED FUNCTIONS



### Pillow Speaker Ready

The hospital TV is equipped with a compatible pillow speaker\* interface, giving patients the ability to control the TV sound and video from their bed.

\* Pillow speaker is not provided by LG. (sold separately)

### Nurse Call System Ready

Through nurse call system provided by a pillow speaker\* connected to LG hospital TV, staff can be called immediately for emergency.

### UL Hospital Grade Listed

The UR762M hospital TV is designed for the healthcare and hospital environment, meeting safety standards by UL.



### Group Telemedicine Ready

The UR772M series NanoCell Hospital TV is ready for web-based telemedicine. System Integrators can develop and deploy their web applications without additional video conferencing equipment for 1:1 or 2:1 remote meetings. Camera angle and zoom control during a session are also possible.\*

\* The feature above requires a separate web application. Supporting camera: Logitech C310, MS lifecam HD-3000

# SMART MANAGEMENT

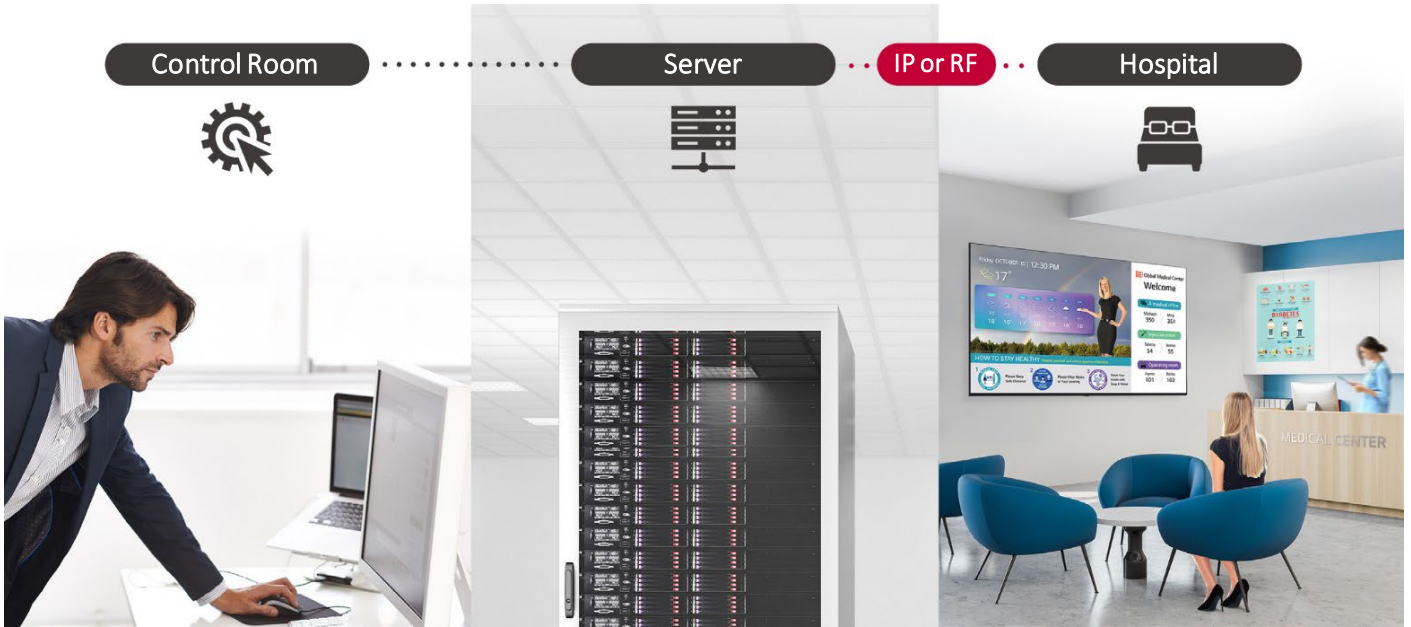

## Pro:Centric Hospital Management Solution

LG’s Pro:Centric Direct is a robust hospital content management solution that offers simple editing tools and provides IP network-based remote management and service capabilities\*. Pro:Centric Direct enables users to edit their interface easily by providing a customized interface and efficient management of all TVs in the hospital.

\* The actual screen may be slightly different. Some features may not be supported based on PCD versions.



## Slim Depth for a Sleek Look

With Nanocell offering a slimmer\* design, the 75UR762M integrates smoothly into hospital interiors.

\* Compared to LG’s previous hospital TV UT672M series



## Pro:Idiom

The 75UR762M provides embedded Pro:Idiom decryption, unlocking access to high-value digital content with Pro:Idiom DRM (Digital Right Management) which prevents illegal copying of the content.

## USER CONVENIENCE



### SoftAP

Software-enabled Access Point (SoftAP) is a "virtual" Wi-Fi feature that enables patients to connect their own devices to the SoftAP by using the TV as a wireless hotspot.\*

\* SoftAP should be set in the installation menu after the TV is turned on. Screen Share may not be operated at the same time.

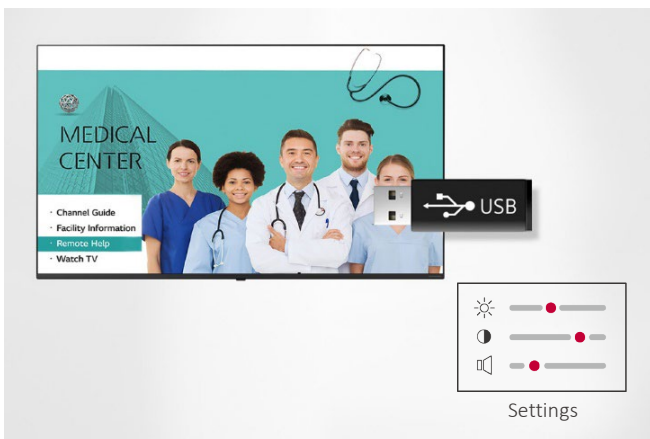

### USB Cloning

USB data cloning makes managing multiple displays easy. Instead of setting up each display one by one, data can be copied to a USB\* for one display, and be sent to the other displays through a USB plug-in.

\* USB is not provided by LG. (sold separately)

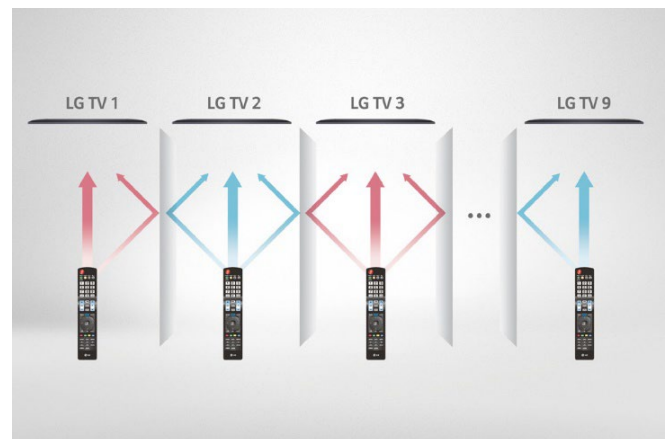

### Multi-code IR

Multi-code IR\* function eliminates any remote-control signal interaction between multiple TVs in one place. LG hospital TV supports this when used with the Multi-code IR remote control, so users can freely control their own TVs without disturbing the others.

\* Multi-code IR remote control is not provided by LG. (sold separately)

# PRODUCT INFORMATION

\* 75 inch

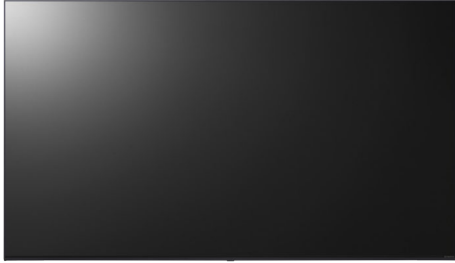

## 75UR762M

Design	Stand Type	No Stand
Display	Diagonal	75"
	Resolution	3,840 × 2,160 (UHD)
	Category	Pro:Centric Smart
Broadcasting	Digital	ATSC, Clear QAM, Analog NTSC
	Analog	NTSC
Solution	Pro:Centric (Smart, Cloud, Direct, V, Server), Quick Menu	

# DIMENSIONS

75"

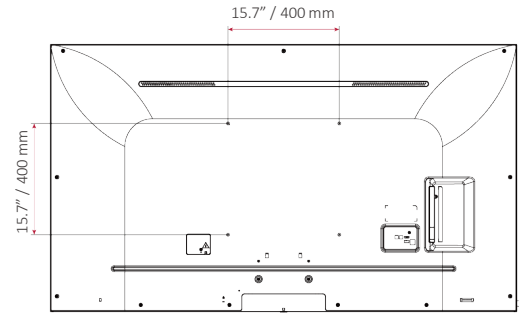
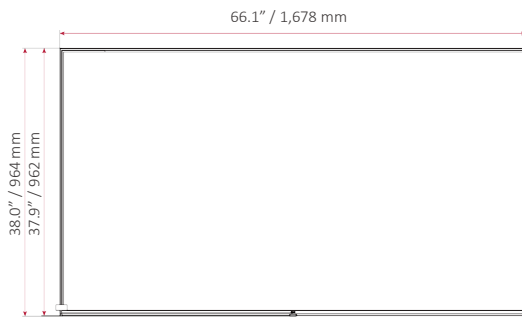

# CONNECTIVITY

Rear

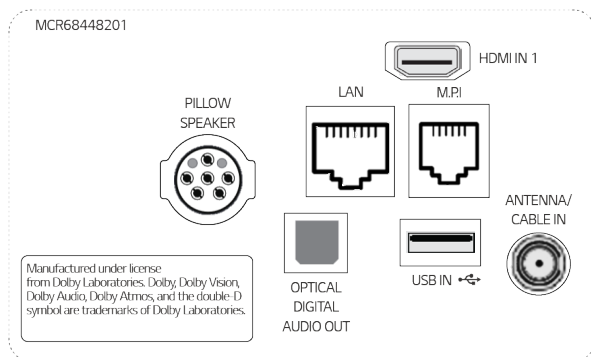

Side

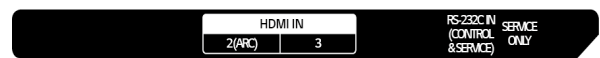

\* Dimensions & Jack Panels may differ from the above image, so please contact LG sales team to verify before ordering.

## SPECIFICATIONS

## 75UR762M

Category	Category	Pro:Centric Smart
Design	Stand Type	No Stand
	Front Color	Dark Charcoal Gray
Display	Inch	75"
	Resolution	3,840 × 2,160 (UHD)
	Nano	Yes
Video	HDR (10 Pro / HLG)	Yes / Yes
Audio	Speakers (Sound Output)	10 W + 10 W
	Speaker System	2.0 ch
	DOLBY ATMOS	No
	LG Sound Sync	Optical/Bluetooth wireless
Broadcasting	Digital (Terrestrial, Cable, Satellite)	ATSC / Clear QAM
	Analog	NTSC
Hospitality Solution	Solution Type	Pro:Centric (Smart, Cloud, Direct, V, Server), Quick Menu 5.0
	DRM	Pro:Idiom
Smart Features	webOS 6.0, Gallery Mode, Web Browser, Pre-loaded App, Magic Remote Compatibility (Ready, MR18HA), SoftAP, Wi-Fi, Screen Share (Miracast), Smart Share, Bluetooth Audio Playback, Voice Recognition (Standalone / Solution), IoT, USB Cloning, SI Compatible (MPI, RS-232C), IR Out (RS-232C, MPI)	
Hospitality Features	Installer Menu, One Channel Map (LCM), Instant ON, Remote App, Required Approval (UL), Pillow Speaker, Video Tag (2 Supported), Anti-theft System (Kensington Lock) <sup>1</sup>	
Connectivity	Set Side	HDMI In 2.0 (x2), RS-232C (3.5 mm TRRS), LG SVC Only (3.5 mm Stereo)
	Set Rear	HDMI In (HDCP 2.0), USB 2.0, RF In (Tuner), Digital Audio Out (Optical), LAN (RJ45), MPI (RJ12), Pillow Speaker Interface (6 Pin)
Mechanical	VESA Compatible	400 × 400 mm
	Dimensions without Stand (W × H × D)	66.1 x 38.0 x 2.4 in. 1,678 × 964 × 59.9 mm
	Weight without Stand	69.2 lbs. / 31.4 kg
	Shipping Weight	91.1 lbs. / 41.3 kg
Electrical	Power Supply (Voltage, Hz)	100-240 Vac, 50/60 Hz
	Power Consumption (Typ. / Max.)	107 W / 225 W
	Standby Power Consumption	Less than 0.5 W
Warranty & Other	Warranty	3 Year Limited
	UPC	1 95174 03729 4
	Certifications	UL, FCC
	Accessories	Chromecast Dongle Anti-theft Cover (Optional), Power Cable (1.8 m, Detached)

<sup>1</sup>This feature supported after purchasing Stand.

\* Specifications are subject to change without notice, so please contact LG sales team to verify before ordering.